

CATALOG | AUGUST 2021

Low voltage

Brake aluminum motors

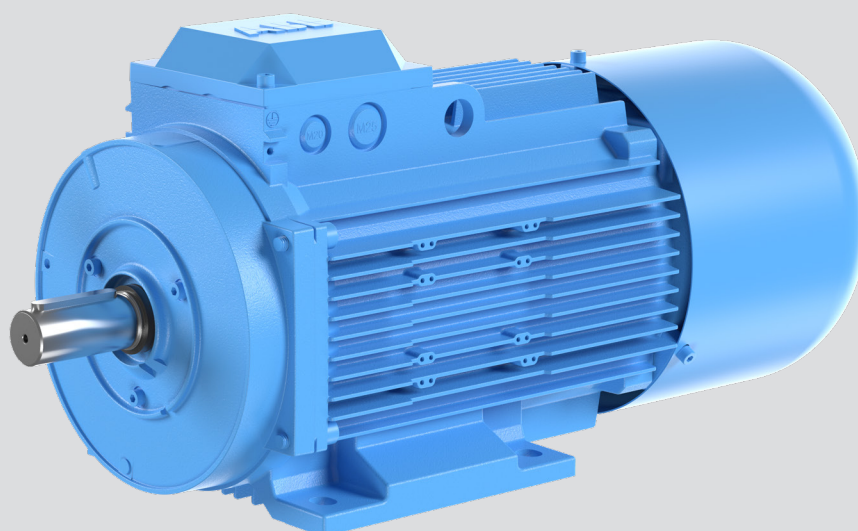

With expertise, and a comprehensive portfolio of products and life-cycle services, we help value-minded industrial customers improve their energy efficiency and productivity.



Low voltage Brake aluminum motors

Sizes 71-180, 0,12 to 22 kW

4	Brake aluminum motors
5	Key features
6	Mechanical design
7	Brake design
12	Ordering information
13	Technical data
13	IE2 Aluminum brake motors
14	IE3 Aluminum brake motors
15	Variant codes
19	Rating plates
20	Dimension drawings
21	Motors in brief
22	Contact us

Brake aluminum motors

Brake motors keep the rotor position fixed when power supply is shut-off and effectively enable to slow down and stop the driven equipment in a short time.

ABB brake aluminum motors are standard motors modified for braking duties, i.e. three phase induction motors with standard dimensions and output rating. The electro-magnetic disc brake is powered by DC current through a rectifier located in terminal box. When the brake coil is de-energized, the brake is actuated by spring pressure.

ABB brake motors are highly acclaimed in the market due to its high performance and ensuring a reliable service over the lifetime. The comprehensive range is offering full compliance to the global standards, high efficiency for energy and cost savings, as well as competitive delivery times.

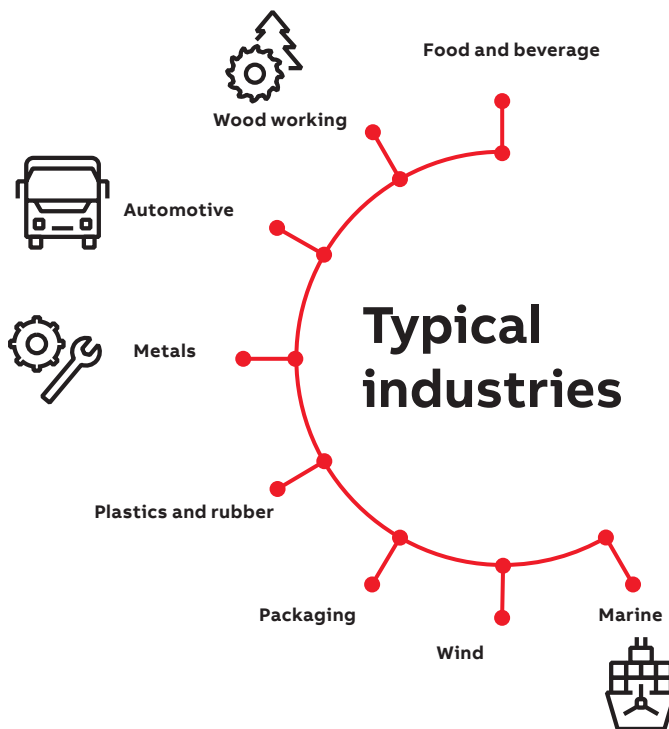

Key features

Motor features

- Easy installation with wide terminal box and brake rectifier included in the terminal box
- Standard connection of the rectifier, directly to motor terminals
- Mounting in any position
- Temperature rise B and insulation class F
- IP 55
- With standard motors' dimensions and output ratings
- Hand release fitted as option
- Technical and application support
- Service and support

Brake features

The pre-assembled electromagnetic brake is in conformity with relevant EU harmonized legislations. It is suitable for parking and emergency stop braking industrial applications.

- Compact design with torque from 5 to 235 Nm
- Brake disc highest security, lowest wear and maintenance
- Easy installation
- IP54 as standard
- Duty cycle: 100% energized is allowed
- Non-stick friction material
- UL certified

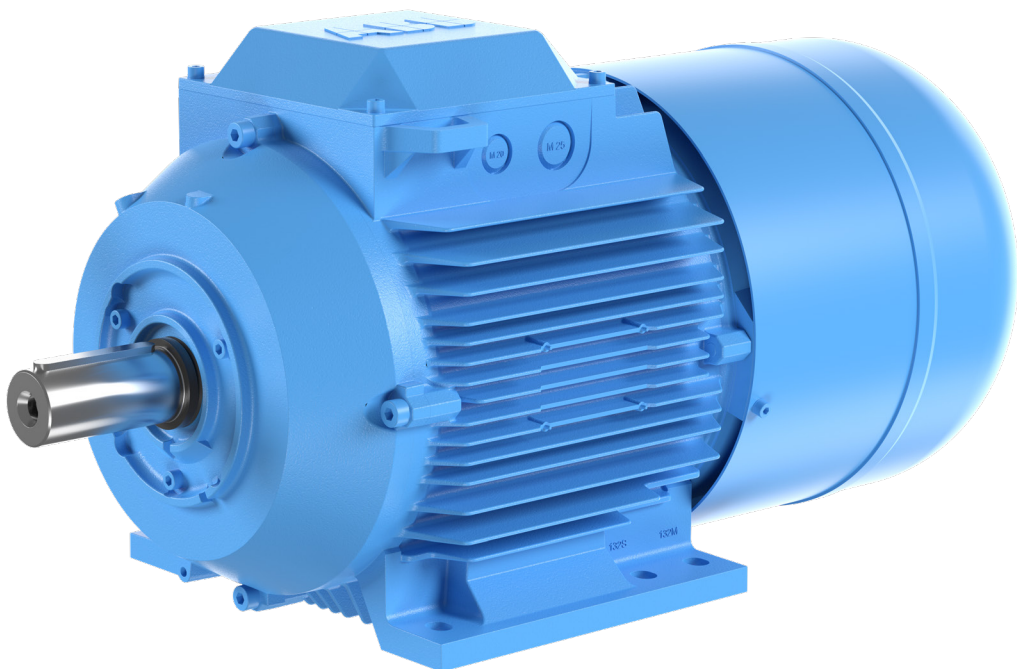

Mechanical design

Degrees of protection

The degree of protection, as per 60034-5, is IP55 for the terminal box, electrical components of the brake and other motor parts.

Mechanical components of the brake IP54.

Mounting arrangements of brake motors

The design of the brake motor enables it to operate in any mounting position. Nevertheless, the position of the drain holes should be taken into account.

Vertically mounted motors with the shaft end downwards, intended for outdoor operation, should be provided with a protective roof to avoid water ingress and the possibility of ice forming on the brake.

Operation

ABB's brake motor is a standard motor modified for braking duties, i.e. a three phase induction motor with standard dimensions and output rating.

The electro-magnetic disc brake is powered, by DC current through a rectifier located in terminal box.

When the brake coil is de-energised, the brake is actuated by spring pressure.

The axial movement of the brake disc performs a dual braking action against the moving electromagnet and the motor shield, without pressure or impact being transmitted to the bearings.

Lubrication and bearings

The bearings incorporate two Z-type non-friction sealing plates. The amount of grease is sufficient for the life of the bearing.

Standard design: deep groove ball bearings as listed below:

Motor size	D-end	N-end
71	6203-2Z/C3	6203-2Z/C3
80	6204-2Z/C3	6204-2Z/C3
90	6205-2Z/C3	6205-2Z/C3
100	6306-2Z/C3	6206-2Z/C3
112	6306-2Z/C3	6206-2Z/C3
132	6308-2Z/C3	6208-2Z/C3
160	6309-2Z/C3	6209-2Z/C3
180	6310-2Z/C3	6209-2Z/C3

Brake design

—
01 Brake disc for frame sizes 71-112 (ERX-35)

—
02 Brake disc for frame sizes 132-180 (ERX-60-200)

General

Electromagnetic disc brakes work by the action of a set of springs and are released when applying voltage to the brake coil.

This means that the motor will brake automatically in case of any voltage failure, as a significant safety feature. The brake is always functional, irrespective of the mounting position of the brake motor.

Detailed view

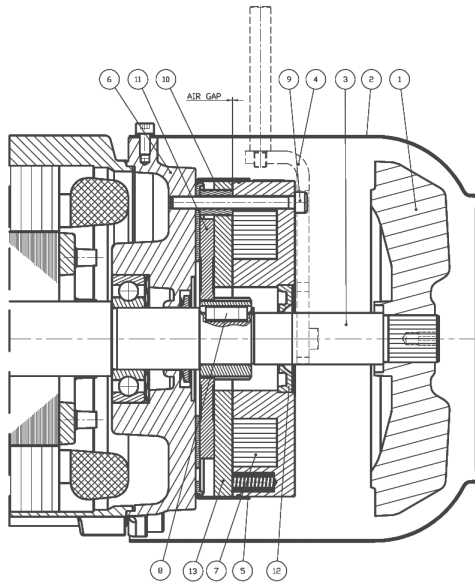

- 1 Fan
- 2 Fan cover
- 3 Shaft
- 4 Hand release lever (option 088)
- 5 Pressure spring
- 6 Motor N-end shield
- 7 Brake magnet
- 8 Brake key
- 9 Mounting screw
- 10 Dust cover
- 11 Brake disc
- 12 Lip seal
- 13 Armature plate

Brake disc

The friction discs have been designed to provide consistent and reliable braking performance in a wide range of conditions.

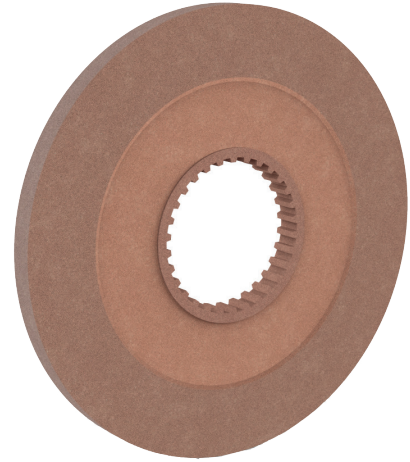

—
01

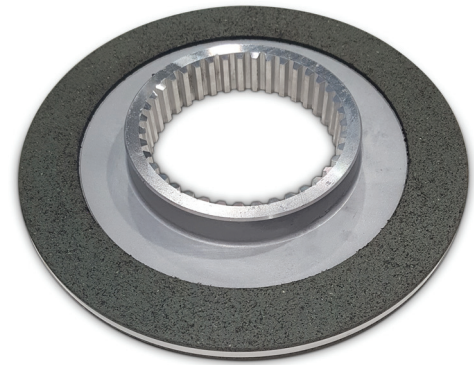

—
02

From the first principle, the friction material has been designed to deliver static and dynamic braking functions with high torque stability. Furthermore, it offers consistent performance across varying rotational speeds and a wide range of environmental conditions. The material is non-sticking with a high friction coefficient.

The friction material was put through a rigorous battery of in-house testing to ensure that it's best-in-class performance.

Replacing the brake disc

The brake disc must be replaced when reaching the maximum airgap stated in Table 1.

Rectifier

The rectifier is a device for DC brake applications. It is highly resistant to temperature as well as to voltage peaks. Its compact design enables it to be placed in the motor terminal box.

Connection for DC brake¹⁾

The brake is fed via a rectifier. The voltage stated on the brake rating plate is that of the brake coil on the DC side of the rectifier.

The coil can operate reliably between of 90 % and 110 % of the rated voltage. For voltages outside these limits, please consult ABB.

Standard brake release time

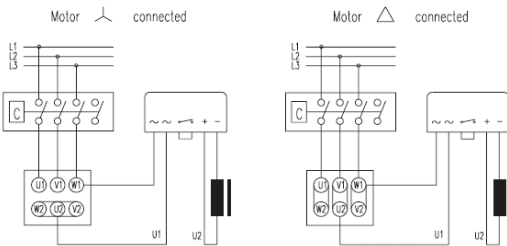

Reconnection (t21=)

To obtain fast braking time, please see table 2 (t21=), use the following diagram.

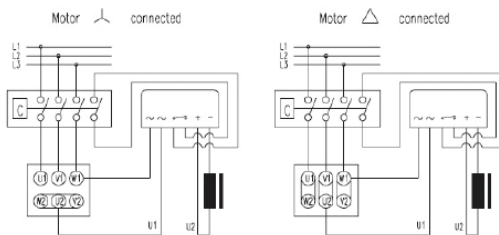

Reconnection (t21~)

When it is necessary to reduce the fast braking time, the connections should be modified according to the following diagram. The breaking of the circuit on the AC side is controlled by using an auxiliary contact of the contactor.

¹⁾ Separate brake connection is compulsory when the motor is driven by a variable speed drive.

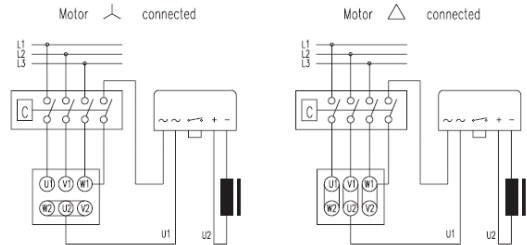

Reconnection of brake for separate ac supply

To obtain separate AC supply, please use following diagram.

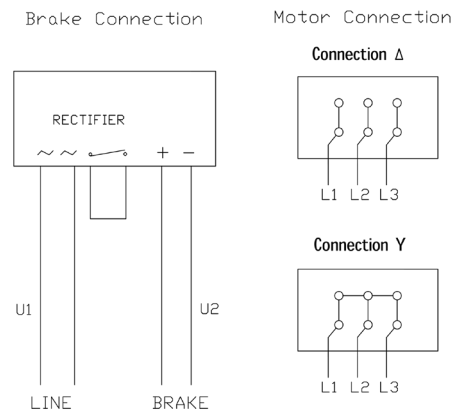

Hand release

The device is a lever used to override the action of the brake springs for as long as it is applied. Hand release is available as an option, see variant code 088.

When installing the release level, please proceed as follows:

ERX5 to ERX60

- 1 Tighten lever handle on lever until to have it blocked.



- 2 Insert lever springs into the brake.
- 3 Put lever screws through the lever and tighten the screws into the brake until to have them blocked.

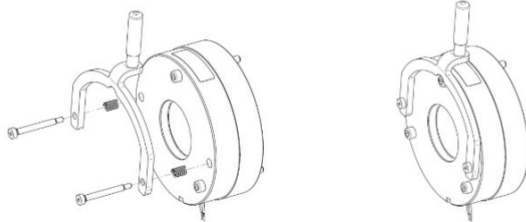

ERX200

- 1 Insert lever pins into the brake with hammer (tight fit).

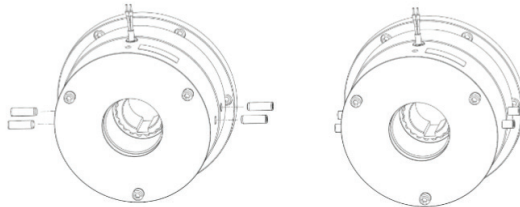

- 2 Insert lever systems on lever pins.

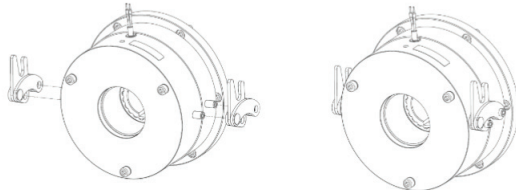

- 3 Insert lever handle in lever systems.

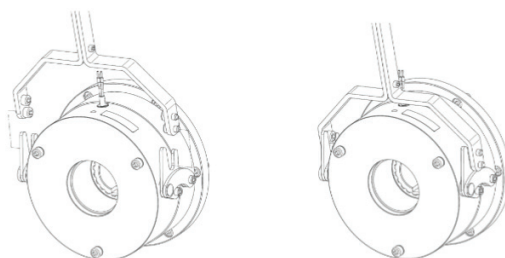

Torque adjustment

In brake motors from frame size 71 up to 180, the braking torque is set to the nominal torque as standard. Reduced braking torque up to 50%, is available by using variant code 087.

Brake operating times

The operating times stated in brake data table 2 are valid for the nominal air gap and warmed-up brake coil.

t_1 = Brake release time

t_{21} = Braking time

U_2 = Rated voltage

T_B = Nominal braking torque

Brake release time = the time from when voltage is applied to the brake coil up to the ceasing of braking action.

Braking time = the time from when the current is switched off up to the starting of braking action.

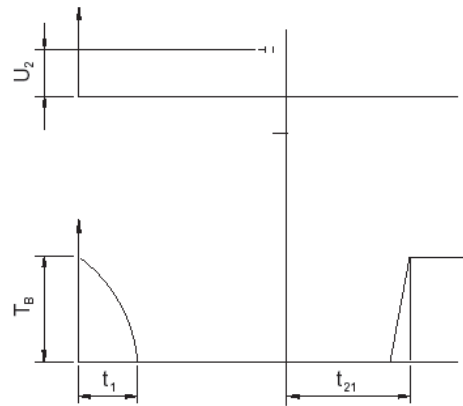

Brake voltages

The standard brake coil connection voltages for 50 Hz will be those stated in the following table, unless stated otherwise in the order:

Rectifier input voltage (V_{ac})	Rectifier type ¹⁾	D.C. coil brake voltage (V)
220	H.W	103
230	H.W	103
240	H.W	103
380	H.W	180
400	H.W	180
415	H.W	180
500	H.W	225 ²⁾
24 V_{DC}	None	24 ³⁾

¹⁾ H.W. = Half-wave rectifier

²⁾ Special coil on request

³⁾ Available using variant code 285

Brake design

Data tables

Table 1.

Brake motor size		71	80	90	100	112	132	160	180
Brake type		ERX 5	ERX 10	ERX 20	ERX 35	ERX 35	ERX 60	ERX 200	ERX 200
Rated torque ¹⁾	T_{Bnom} (Nm)	4	8	16	32	40	80	165	235
Nominal air gap	X (mm)	0.25	0.25	0.25	0.25	0.25	0.25	0.35	0.35
Maximum air gap	Xn (mm)	0.6	0.6	0.6	0.6	0.6	0.6	0.7	0.7
Thickness of new brake disc	E_m (mm)	6.5	8.1	7	7	7	7.9	8	8
Tightening torque: bolt	C_s (Nm)	2.7	5.2	9	9	9	22	22	22
Max. Input coil:									
- DC brake motor	(W)	19-23	20-25	36-39	42-47	42-47	36-59	69-85	69-85
Moment of inertia	J (kgm ²)	4.5x10 ⁻³	1.2x10 ⁻²	3.2x10 ⁻²	1x10 ⁻¹	1x10 ⁻¹	1.7x10 ⁻¹	3.6x10 ⁻¹	5.8x10 ⁻¹
Weight	(kg)	1.3	1.6	3.8	5	5	6.6	14	14

¹⁾ Rated torque is guaranteed for the brand new brakes (no running or burnishing required)

In general, all the variables mentioned above can affect the braking torque values, so if an accurate value is needed, ABB recommends it is measured in the real application.

Graph 1.

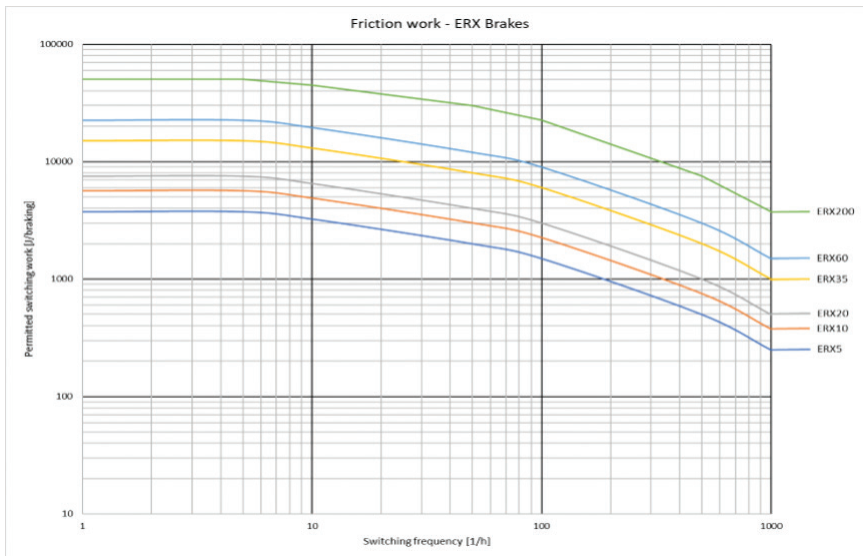

Table 2.

Brake motor sizes		71	80	90	100/112	132	160	160/180
DC Brake size		ERX 5	ERX 10	ERX 20	ERX 35	ERX 200	ERX 200	ERX 200
Brake release time t_1	ms	70	90	110	130	180	350	350
Standard braking time t_{21} (AC)	ms	250	250	500	700	750	650	650
Fast braking time t_{21f} (DC)	ms	30	30	50	80	160	100	100

Brake design

Calculations

Maximum number of connection per hour

The connection frequency that may be achieved with the motors is limited by the temperature rise that they undergo both in the coil and in the rotor. The brakes are designed so that they may withstand the kinds of duty for which these motors are intended.

The maximum number of connections per hour depends on:

- the power P_2 required after reaching the rated speed, i.e. the relative load P with regard to the rated power P_n

$$P = \frac{P_2}{P_n} \times 100 \%$$

- the total inertia J in kgm^2 of the mass to be accelerated (inertia of the rotor J_m as per catalogue, plus the additional inertia J_b of the driven machine) in relation to the motor shaft, that is, J_b multiplied by the square of the coefficient of the load speed divided by the motor speed.

$$J = J_m + J_b \times \left[\frac{n_b}{n_m} \right]^2$$

- the relative duration factor for service S4.

$$S4 = \frac{\text{connection time}}{\text{connection time} + \text{downtime}} \times 100 \text{ in } \%$$

For calculations of the maximum number of connections/hour, please consult ABB.

Required data:

- Type of brake motor
- Load inertia reduced at motor shaft
- Required power P_2
- Type of service

Permitted friction work per operation

Friction work per operation must not exceed the WRmax values stated in brake data table 1.

$$WR = \frac{1}{2} \times J \left[\frac{\pi \times n_m}{30} \right]^2 \text{ in joules}$$

Friction work per hour

The friction work can be calculated if the number of operations per hour is known.

This value must be equal to or less than the PR_{max} stated in brake data table 1.

$$PR = WR \times c/h$$

Options

When the motor is supplied via a frequency converter, the brake should be supplied separately at rated voltage (constant). The separate brake supply can be connected directly, no separate terminal box is needed.

Braking torque reduction

Reduced braking torque range, from 100 % up to 50 %, is available by using variant code 087.

Protective roof

To protect motors from accumulation of water, ice or snow when installed outdoors in the vertical position and with the shaft downwards, the assembly should be fitted with a protective roof.

Variant code 005 should in this case be stated in the order.

Ordering information

Explanation of the product code

Motor type	Motor size	Product code	Code for mounting arrangement, Voltage and frequency code, Generation code followed by variant codes
M3AA	112MB	3GAA 111	320 - ASK, 843, 003 etc.
		1 2 3 4 5 6 7	8 9 10 11 12 13 14...

Positions 1 to 4			
3GAA: Totally enclosed motor with aluminum stator frame			
Positions 5 and 6			
IEC size		IEC size	
07:	71	11:	112
08:	80	13:	132
09:	90	16:	160
10:	100	18:	180
Position 7			
Pole pairs			
1:	2 poles		
2:	4 poles		
3:	6 poles		
4:	8 poles		
Positions 8 to 10			
Running number			
Position 11			
- (dash)			
Position 12 (marked with black dot in data tables)			
Mounting arrangement			
A:	Foot-mounted motor		
B:	Flange-mounted motor. Large flange with clearance holes.		
C:	Flange-mounted motor. Small flange with tapped holes.		
E:	Flange-mounted motor. Large flange with clearance holes, available for frame sizes 112-132.		
F:	Foot- and flange-mounted motor. Special flange.		
H:	Foot- and flange-mounted motor. Large flange with clearance holes.		
J:	Foot- and flange-mounted motor. Small flange with tapped holes.		
N:	Flange-mounted motor; CI ring flange FF.		
P:	Foot- and flange-mounted motor; CI ring flange FF.		

Position 13 (marked with black dot in data tables)	
Voltage and frequency code	
Single-speed motors	
B:	380 VΔ 50 Hz
D:	400 VΔ, 415 VΔ, 690 VY 50 Hz
E:	500 VΔ 50 Hz
F:	500 VY 50 Hz
S:	230 VΔ, 400 VY, 415 VY 50 Hz
X:	Other rated voltage, connection or frequency, 690 V maximum
Remark: For voltage code X the variant code "209 Non-standard voltage or frequency (special winding)" must be ordered.	

Position 14	
Version	
A, B, C...:	Generation code followed by variant codes

Efficiency values are given according to IEC 60034-2-1; 2014

For detailed dimension drawings please see our web-pages 'www.abb.com/motors&generators' or contact ABB.

Note: By ordering the motors variant code 843 for the DC brake needs to be added.

Technical data

IE2 Aluminum brake motors

IP 55 - IC 411 - Insulation class F, temperature rise class B - Brake IP54
IE2 efficiency class according to IEC 60034-30-1; 2014

Output kW	Motor type designation	Product code ¹⁾	Speed r/min	Efficiency IEC 60034-30-1; 2014			Power factor Cos(φ)	Current		Torque		Moment of inertia J = 1/4 GD ² kgm ²	Weight kg	Sound pressure Level L _{PA} dB	
				Full load 100%	3/4 load 75%	1/2 load 50%		I _N A	I _S /I _N	T _N Nm	T _i /T _N				T _b /T _N
3000 r/min = 2 poles				400 V 50 Hz											
0,37	M3AA 71A 2	3GAA071311-...E	2785	69,5	70,8	67,8	0,79	0,91	4,6	1,26	2,5	2,8	0,0004	7,5	58
0,55	M3AA 71B 2	3GAA071312-...E	2790	74,1	75,4	73,4	0,79	1,29	5,1	1,88	3,1	3,1	0,0005	7,5	58
1500 r/min = 4 poles				400 V 50 Hz											
0,25	M3AA 71A 4	3GAA072311-...E	1430	68,5	66,8	59,5	0,67	0,76	4,7	1,67	2,2	3,0	0,0006	7,5	45
0,37	M3AA 71B 4	3GAA072312-...E	1411	72,7	73,3	69,9	0,74	0,96	5,2	2,5	2,6	2,9	0,001	8,5	45
0,55	M3AA 80A 4	3GAA082311-...E	1406	77,1	78,6	78,6	0,78	1,29	5,4	3,73	2,8	2,6	0,0022	11,5	50
1000 r/min = 6 poles				400 V 50 Hz											
0,18	M3AA 71A 6	3GAA073311-...E	870	56,6	58,7	54,8	0,71	0,61	2,8	1,97	1,9	2,0	0,0009	8	42
0,25	M3AA 71B 6	3GAA073312-...E	890	61,6	61,8	56,7	0,68	0,84	3,1	2,68	2,3	2,4	0,0012	9	42
0,37	M3AA 80A 6	3GAA083311-...E	923	67,6	67,5	62,6	0,73	1,04	4,4	3,82	2,6	2,8	0,0019	12	47
0,55	M3AA 80C 6	3GAA083313-...E	905	73,1	75,9	75,1	0,76	1,42	4,4	5,8	2,7	2,55	0,0034	18	50
750 r/min = 8 poles				400 V 50 Hz											
0,12	M3AA 71B 8	3GAA074002-...E	680	39,8	36,4	26,6	0,60	0,56	2,3	1,68	2,2	2,3	0,0012	9	43
0,25	M3AA 80B 8	3GAA084002-...E	675	50,6	52,2	46,4	0,61	0,97	3,0	3,53	2,1	2,3	0,0024	12,5	50

¹⁾ Note: Mandatory variant codes 843 for DC brake.

Technical data

IE3 Aluminum brake motors

IP 55 - IC 411 - Insulation class F, temperature rise class B - Brake IP54
IE3 efficiency class according to IEC 60034-30-1; 2014

Output kW	Motor type designation	Product code ¹⁾	Speed r/min	Efficiency IEC 60034-30-1; 2014			Power factor Cos(φ)	Current		Torque		Moment of inertia J = 1/4 GD ² kgm ²	Weight kg	Sound pressure Level L _{PA} dB	
				Full load 100%	3/4 load 75%	1/2 load 50%		I _N A	I _s /I _N	T _N Nm	T _i /T _N				T _b /T _N
				400 V 50 Hz											
3000 r/min = 2 poles															
0,75	M3AA 80MB 2	3GAA081320-**-K	2894	83,1	82,8	80,0	0,74	1,74	7,9	2,4	3,7	4,2	0,0008	12,5	57
1,1	M3AA 80MC 2	3GAA081330-**-K	2883	83,9	83,6	82,0	0,81	2,3	7,9	3,6	3,7	4,2	0,001	13,5	56
1,5	M3AA 90LB 2	3GAA091520-**-K	2906	86,1	86,6	86,5	0,89	2,8	7,9	4,9	2,3	3,3	0,0027	23	60
2,2	M3AA 90LC 2	3GAA091530-**-K	2900	87,4	88,8	88,9	0,89	4,0	8,3	7,2	2,9	3,5	0,0032	26	60
3	M3AA 100LC 2	3GAA101530-**-K	2896	87,9	88,9	88,7	0,90	5,4	8,4	9,8	3,2	3,9	0,0057	36	62
4	M3AA 112MB 2	3GAA111320-**-K	2888	88,5	89,8	90,0	0,91	7,1	8,4	13,2	3,2	4,0	0,0104	48	68
5,5	M3AA 132SB 2	3GAA131120-**-K	2901	89,3	90,0	90,2	0,91	9,7	7,9	18,1	2,3	3,4	0,0154	73	68
7,5	M3AA 132SC 2	3GAA131130-**-K	2909	90,7	91,8	92,0	0,90	13,1	8,3	24,6	3,0	3,9	0,0173	78	70
11	M3AA 160MLA 2	3GAA161410-**-K	2943	91,2	92,0	91,6	0,91	19,1	7,2	35,57	2,6	3,6	0,057	125	69
15	M3AA 160MLB 2	3GAA161420-**-K	2947	91,9	92,2	91,8	0,88	26,7	8,2	48,6	3,2	4,2	0,063	142	69
18,5	M3AA 160MLC 2	3GAA161430-**-K	2949	92,4	93,0	92,6	0,90	32,1	9,0	59,9	3,3	3,9	0,076	156	73
22	M3AA 180MLA 2	3GAA181410-**-K	2956	92,7	93,1	92,7	0,90	37,7	7,8	71	3,0	3,8	0,11	194	73
1500 r/min = 4 poles															
0,75	M3AA 80ME 4	3GAA082350-**-K	1440	84,0	83,9	81,9	0,76	1,7	7,9	4,9	3,3	3,7	0,0027	16,5	54
1,1	M3AA 90LC 4	3GAA092530-**-K	1442	85,6	85,1	83,4	0,80	2,3	7,9	7,2	3,3	3,9	0,0055	25	56
1,5	M3AA 90LD 4	3GAA092540-**-K	1439	85,3	84,7	82,8	0,78	3,2	8,2	9,9	3,5	4,0	0,0055	25	51
2,2	M3AA 100LE 4	3GAA102550-**-K	1454	89,1	89,5	88,6	0,83	4,3	8,9	14,5	3,1	4,1	0,0144	44	54
3	M3AA 100LF 4	3GAA102560-**-K	1452	88,8	89,2	88,3	0,83	5,9	9,0	19,7	3,5	4,2	0,0144	44	54
4	M3AA 112MB 4	3GAA112320-**-K	1451	88,6	89,4	89,0	0,77	8,6	7,6	26,3	3,1	4,1	0,018	58	59
5,5	M3AA 132MB 4	3GAA132320-**-K	1464	89,6	90,2	89,5	0,78	11,4	7,0	35,9	2,8	3,9	0,0295	83	70
7,5	M3AA 132MC 4	3GAA132330-**-K	1464	90,6	91,0	90,9	0,81	14,7	7,7	48,9	2,5	3,6	0,0414	83	64
11	M3AA 160MLA 4	3GAA162410-**-K	1477	91,4	91,8	91,1	0,82	21,1	7,6	71,3	2,6	3,3	0,11	145	61
15	M3AA 160MLB 4	3GAA162420-**-K	1474	92,1	92,2	91,3	0,81	29	7,8	97,2	3,0	3,6	0,135	159	61
18,5	M3AA 180MLA 4	3GAA182410-**-K	1481	92,6	93,2	92,9	0,83	34,9	7,2	119	2,8	3,0	0,219	195	60
22	M3AA 180MLB 4	3GAA182420-**-K	1480	93,3	94,1	94,1	0,82	41,5	8,2	141	2,8	3,1	0,217	194	62
1000 r/min = 6 poles															
0,75	M3AA 90LD 6	3GAA093540-**-K	937	80,3	80,5	79,5	0,76	1,8	4,6	7,6	2,1	2,3	0,0055	25	55
1,1	M3AA 100LE 6	3GAA103550-**-K	963	84,0	85,0	84,0	0,69	2,6	5,6	10,9	2,3	3,1	0,0138	43	49
1,5	M3AA 100LF 6	3GAA103560-**-K	969	85,7	85,9	84,2	0,65	3,7	7	14,7	3,3	4,1	0,0138	43	49
2,2	M3AA 112MC 6	3GAA113330-**-K	967	87,2	87,9	87,1	0,69	5,2	6,5	21,7	2,4	3,5	0,0187	53	68
3	M3AA 132MC 6	3GAA133330-**-K	978	88,5	88,8	87,7	0,69	7,0	6,2	29,2	2,0	3,0	0,0402	81	61
4	M3AA 132MD 6	3GAA133340-**-K	973	88,5	89,3	89,1	0,72	9,1	5,6	39,2	1,9	2,7	0,0402	82	61
5,5	M3AA 132ME 6	3GAA133350-**-K	973	89,5	90,2	89,6	0,74	12	5,8	53,9	2	2,9	0,039	78	61
7,5	M3AA 160MLA 6	3GAA163410-**-K	980	90,8	91,5	91,0	0,78	15,2	7,9	73	1,7	3,3	0,114	144	59
11	M3AA 160MLB 6	3GAA163420-**-K	979	91,2	91,8	91,1	0,74	23,5	8,5	107	2,2	3,9	0,131	158	59
15	M3AA 180MLA 6	3GAA183410-**-K	987	92,2	92,5	91,5	0,77	30,4	5,5	146	1,7	2,7	0,225	193	59
750 r/min = 8 poles															
1,1	M3AA 100LD 8	3GAA104540-**-K	703	77,7	77,7	74,7	0,65	3,1	4,4	15	2,7	2,9	0,0128	41	53
1,5	M3AA 112MC 8	3GAA114330-**-K	717	79,7	80,1	78,8	0,62	4,1	4,3	20	1,8	2,6	0,0194	53	55
2,2	M3AA 132SA 8	3GAA134110-**-K	725	81,9	82,3	80,2	0,64	5,8	5,2	29	2,0	3,0	0,0291	66	57
3	M3AA 132MA 8	3GAA134310-**-K	723	83,5	84,1	82,8	0,66	7,5	4,8	40	1,8	2,8	0,0375	75	57
4	M3AA 160MLA 8	3GAA164410-**-K	734	84,8	85,1	83,2	0,65	10,3	4,5	52	1,8	2,3	0,091	113	59
5,5	M3AA 160MLB 8	3GAA164420-**-K	732	86,2	87,1	86,1	0,69	13	5,0	72	2,0	2,4	0,091	115	59
7,5	M3AA 160MLC 8	3GAA164430-**-K	733	87,3	88,2	87,2	0,69	17,6	5,1	98	2,0	2,4	0,12	139	59
11	M3AA 180MLA 8	3GAA184410-**-K	731	88,6	89,2	88,4	0,70	25,3	5,0	144	2,1	2,1	0,2	179	59

¹⁾ Note: Mandatory variant codes 843 for DC brake.

Variant codes

Variant codes specify additional options and features to the standard motor. The desired features are listed as three-digit variant codes in the motor order. Note also that there are variants that cannot be used together.

Most of the variant codes apply to IE2 and IE3 motors. For details please contact you ABB sales office before making an order.

Code/Variant	Frame size							
	71	80	90	100	112	132	160	180
Brakes								
087 Brake with reduced torque, 50% of nominal torque.	-	-	•	•	•	•	•	•
088 Brake with mechanical release.	-	-	•	•	•	•	•	•
285 Reconnection of brake for separate dc supply at 24V.	-	-	•	•	•	•	•	•
298 Brake motor for 460V AC with voltage code S and D	-	-	•	•	•	•	•	•
843 DC brake	○	○	○	○	○	○	○	○
Administration								
529 Customer witnessed visual inspection of complete order line.			•	•	•	•	•	•
531 Sea freight packing	•	•	•	•	•	•	•	•
533 Wooden sea freight packing	•	•	•	•	•	•	•	•
Balancing								
423 Balanced without key.	•	•	•	•	•	•	•	•
424 Full-key balancing	•	•	•	•	•	•	•	•
Bearings and Lubrication								
036 Transport lock for bearings.	-	-	•	•	•	•	•	•
037 Roller bearing at D-end.	-	-	•	•	•	•	•	•
038 Ball bearing at D-end.	-	-	-	-	-	-	○	○
039 Cold-resistant grease	•	•	•	•	•	•	○	○
040 Heat-resistant grease	•	•	•	•	•	•	○	○
041 Bearings regreasable via grease nipples.	-	-	-	-	•	•	•	•
042 Locked D-end	-	-	-	-	-	-	○	○
043 SPM compatible nipples for vibration measurement	-	-	-	-	•	•	•	•
057 2RS bearings at both ends.	•	•	•	•	•	•	•	•
194 2Z bearings greased for life at both ends.	-	○	○	○	○	○	○	○
195 Bearings greased for life.	-	-	-	-	-	-	○	○
Branch standard designs								
178 Stainless steel / acid proof bolts.	•	•	•	•	•	•	•	•
209 Non-standard voltage or frequency, (special winding).	•	•	•	•	•	•	•	•
217 Cast iron D-end shield (on aluminum motor).	-	-	•	•	•	•	○	○
232 Cast iron N-end shield (on aluminium motor).	○	○	○	○	○	○	○	○
425 Corrosion protected stator and rotor core.	•	•	•	•	•	•	•	•
Cooling system								
053 Metal fan cover.	○	○	○	○	○	○	○	○
068 Light alloy metal fan	•	•	•	•	•	•	•	•
183 Separate motor cooling (fan axial, N-end).	•	•	•	•	•	•	•	•
Documentation								
141 Binding 2D main dimension drawing.	•	•	•	•	•	•	•	•
536 Photos of manufactured motors	•	•	•	•	•	•	•	•

○ = Included as standard | • = Available as option | - = Not applicable

Code/Variant	Frame size							
	71	80	90	100	112	132	160	180
Drain holes								
065	Plugged existing drain holes.	•	•	•	•	•	•	•
Earthing Bolt								
067	External earthing bolt.	•	•	•	•	•	•	•
Heating elements								
450	Heating element, 100-120 V	•	•	•	•	•	•	•
451	Heating element, 200 - 240 V	•	•	•	•	•	•	•
Insulation system								
014	Winding insulation class H.	•	•	•	•	•	•	•
405	Special winding insulation for frequency converter supply.	-	-	•	•	•	•	•
Marine								
496	Fulfilling Bureau Veritas (BV) requirements, without certificate(non-essential duty only)	•	•	•	•	•	•	•
Mounting arrangements								
008	IM 2101 foot/flange mounted, IEC flange, from IM 1001 (B34 from B3).	•	•	•	•	•	-	-
009	IM 2001 foot/flange mounted, IEC flange, from IM 1001 (B35 from B3).	•	•	•	•	•	•	•
047	IM 3601 flange mounted, IEC flange, from IM 3001 (B14 from B5).	•	•	•	•	•	-	-
048	IM 3001 flange mounted, IEC flange, from IM 3601 (B5 from B14).	•	•	•	•	•	-	-
066	Modified for specified mounting position differing from IM B3 (1001), IM B5 (3001), B14 (3601), IM B35 (2001), IM B34 (2101)	•	•	•	•	•	•	•
200	Flange ring holder.	•	•	•	•	•	-	-
218	Flange ring FT 85.	•	•	•	-	-	-	-
219	Flange ring FT 100.	•	•	•	-	-	-	-
220	Flange ring FF 100.	•	•	•	-	-	-	-
223	Flange ring FF 115.	•	•	•	-	-	-	-
224	Flange ring FT 115.	•	•	•	-	-	-	-
226	Flange ring FF 130.	•	•	•	•	•	-	-
227	Flange ring FT 130.	•	•	•	•	•	-	-
229	Flange FT 130.	-	-	-	•	•	-	-
233	Flange ring FF 165.	-	•	•	•	•	-	-
234	Flange ring FT 165.	•	•	•	•	•	-	-
235	Flange FF 165.	-	-	•	-	-	-	-
236	Flange FT 165.	-	-	-	-	-	•	-
243	Flange ring FF 215.	-	-	-	-	•	•	-
244	Flange ring FT 215.	-	-	-	•	•	•	-
245	Flange FF 215.	-	-	-	•	•	-	-
253	Flange ring FF 265.	-	-	-	-	-	•	-
254	Flange ring FT 265.	-	-	-	-	-	•	-
255	Flange FF 265.	-	-	-	-	-	•	-
260	Flange FT 115.	-	-	•	-	-	-	-
Painting								
114	Special paint color, standard grade	•	•	•	•	•	•	•
Protection								
005	Protective roof	•	•	•	•	•	•	•
072	Radial seal at D-end. Not possible for 2-pole , 280 and 315 frames	•	•	•	•	•	•	•
784	Gamma-seal at D-end.	•	•	•	•	•	•	•

○ = Included as standard | ● = Available as option | - = Not applicable

Code/Variant	Frame size							
	71	80	90	100	112	132	160	180
Rating & instruction plates								
002	Restamping voltage, frequency and output, continuous duty.	•	•	•	•	•	•	•
004	Additional text on std rating plate (max 12 digits on free text line).	•	•	•	•	•	•	•
095	Restamping output (maintained voltage, frequency), intermittent duty.	•	•	•	•	•	•	•
098	Stainless rating plate.	•	•	•	•	•	•	•
135	Mounting of additional identification plate, stainless.	•	•	•	•	•	•	•
138	Mounting of additional identification plate, aluminium.	•	•	•	•	•	•	•
139	Additional identification plate delivered loose.	•	•	•	•	•	•	•
159	Additional plate with text Made in	•	•	•	•	•	•	•
160	Additional rating plate affixed.	-	-	•	•	•	•	•
161	Additional rating plate delivered loose.	•	•	•	•	•	•	•
162	Rating plate fixed to stator.	•	•	•	•	•	•	•
163	Frequency converter rating plate. Rating data according to quotation.	•	•	•	•	•	•	•
198	Aluminum rating plate.	○	○	○	○	○	○	○
270	Additional rating plate with standard data, delivered loose	•	•	•	•	•	•	•
Shaft & Rotor								
069	Two shaft extensions according to catalog drawings.	-	-	•	•	•	•	•
070	Special shaft extension at D-End, standard shaft material	•	•	•	•	•	•	•
131	Motor delivered with half key (key not exceeding shaft diameter)	-	-	•	•	•	•	•
Standards and Regulations								
208	Fulfilling Underwriters Laboratories (UL), listed requirements	-	-	•	•	•	•	•
331	IE1 motor not for sale for use in EU	•	•	•	•	•	•	•
538	CE mark	○	○	○	○	○	○	○
548	Certificate of conformity according TR-CU 004/2011 for customs union RU, KZ, BY, AM, KG.	-	•	•	•	•	•	•
Stator winding temperature sensors								
121	Bimetal detectors, break type (NCC), (3 in series), 130 °C, in stator winding	•	•	•	•	•	•	•
122	Bimetal detectors, break type (NCC), (3 in series), 150 °C, in stator winding	•	•	•	•	•	•	•
123	Bimetal detectors, break type (NCC), (3 in series), 170 °C, in stator winding	•	•	•	•	•	•	•
124	Bimetal detectors, break type (NCC), (3 in series), 140 °C, in stator winding	-	-	-	-	-	•	•
125	Bimetal detectors, break type (NCC), (2x3 in series), 150 °C, in stator winding	-	•	•	•	•	•	•
127	Bimetal detectors, break type (NCC), (3 in series, 130 °C & 3 in series, 150 °C), in stator winding	•	•	•	•	•	•	•
321	Bimetal detectors, closing type (NO), (3 in parallel), 130°C, in stator winding.	-	-	•	•	•	•	-
322	Bimetal detectors, closing type (NO), (3 in parallel), 150°C, in stator winding.	-	-	•	•	•	•	-
435	PTC - thermistors (3 in series), 130 °C, in stator winding	•	•	•	•	•	•	•
436	PTC - thermistors (3 in series), 150 °C, in stator winding	•	•	•	○	○	○	○
437	PTC - thermistors (3 in series), 170 °C, in stator winding	•	•	•	•	•	•	•
439	PTC - thermistors (2x3 in series), 150 °C, in stator winding	•	•	•	•	•	•	•
441	PTC - thermistors (3 in series, 130 °C & 3 in series, 150 °C), in stator winding	•	•	•	•	•	•	•
442	PTC - thermistors (3 in series, 150 °C & 3 in series, 170 °C), in stator winding	-	-	•	•	•	•	•
445	Pt100 2-wire in stator winding, 1 per phase	-	-	•	•	•	•	•
446	Pt100 2-wire in stator winding, 2 per phase	-	-	-	-	-	•	•



○ = Included as standard | • = Available as option | - = Not applicable

Code/Variant	Frame size								
	71	80	90	100	112	132	160	180	
Terminal box									
016	9 terminals in terminal box	-	-	•	•	•	•	-	-
230	Standard metal cable gland.	•	•	•	•	•	•	•	•
375	Standard plastic cable gland	•	•	•	•	•	•	-	-
731	Two standard metal cable glands.	•	•	•	•	•	•	•	•
738	Prepared for metric cable glands.	-	-	-	-	-	-	○	○
739	Prepared for metric cable glands according to DIN 42925, draft aug. 1999.	-	-	-	-	•	•	-	-
Testing									
145	Type test report from a catalogue motor, 400V 50Hz.	•	•	•	•	•	•	•	•
146	Type test with report for one motor from specific delivery batch.	•	•	•	•	•	•	•	•
147	Type test with report for motor from specific delivery batch, customer witnessed.	-	-	•	•	•	•	•	•
148	Routine test report.	•	•	•	•	•	•	•	•
221	Type test and multi-point load test with report for one motor from specific delivery batch.	-	-	-	-	-	•	•	•
222	Torque/speed test, type test and multi-point load test with report for one motor from specific delivery batch.	-	-	•	•	•	•	•	•
760	Vibration level test	-	-	•	•	•	•	•	•
762	Noise level test for one motor from specific delivery batch.	-	-	•	•	•	•	•	•
Variable speed drives									
661	1024 Pulse tacho mounted, Hohner series 59, 11-30V	-	-	•	•	•	•	-	-

○ = Included as standard | • = Available as option | - = Not applicable

Rating plates

The brake motor plates have the following arrangement:

		ABB Sp. z o.o. ul. Placydowska 27 95-070 Aleksandrów Łódzki Poland					
		IE3		IEC60034-1			
3~ Motor		M3AA 90 LC 4 IMB5/IM3001				2021	
3516109-1							
No. 3G1P211900690							
V	Hz	kW	r/min	A	cos φ	F	IP 55
400 Y	50	1.1	1442	2.3	0.80		S1
230 D	50	1.1	1442	4	0.80		S1
380 Y	50	1.1	1435	2.3	0.83		S1
220 D	50	1.1	1435	4.1	0.83		S1
415 Y	50	1.1	1446	2.3	0.78		S1
IE3-85.2%(100%)-85.2%(75%)-83.9%(50%)							
Product code 3GAA092530-BSK843							
6205-2Z/C3		6205-2Z/C3				24 kg	
							

Dimension drawings

Brake motors, sizes 71-80

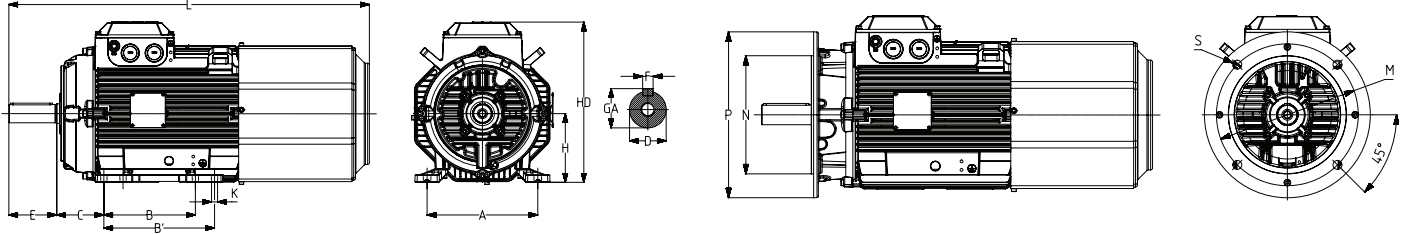

	IM B3 (IM 1001), IM 1002										IM B5 (IM3001), IM 3002				IMB14 (IM3601)				
Motor size	D	GA	F	E	L max	A	B	B'	C	HD	K	M	N	P	S	M	N	P	S
71	14	12.5	5	30	312	112	90		45	180	7	110	160	10	12	85	70	105	6
80	19	21.5	6	40	379	125	100		50	193.5	10	130	200	12	12	100	80	120	6
90	24	27	8	50	418	140	125		56	217	10	130	200	12	12	115	95	140	8
100	28	31	8	60	533.5	160	140		63	237	12	180	250	15	12	130	110	160	8
112	28	31	8	60	556.5	190	140		70	260	12	180	250	15	14.5	130	110	160	8
132	38	41	10	80	611.5	216	140	178	89	298	12	230	300	14.5	14.5	165	130	200	10
160 ¹⁾	42	45	12	110	705	254	210	254	105	370	15	250	350	19	14.5				
160	42	45	12	110	802	254	210	254	108	370	15	250	350	19	14.5				
180	48	51.5	14	110	847	279	279	279	121	405	15	250	350	19	14.5				

Tolerances		Tolerances	
A, B	±0,8	F	ISO h9
D	ISO j6 ≤ Ø 28 mm	H	-0,5
	ISO k6 < Ø 38 mm	N	ISO js6
	ISO m6 ≥ Ø 55 mm	C	±0,8

¹⁾ IE3 160 MLA 2-pole

Motors in brief

Brake motors

Motor size		71	80	90	100	112	132	160	180
Stator and end shields	Material stator	Die-cast aluminum alloy							
	Material D-end	Die-cast aluminum alloy							Cast iron
	Material N-end	Cast iron							
	Paint colour shade	Munsell blue 8B 4.5/3.25							
	Corrosion class	C3 according to IEO/EN 12944-5							
Feet	Material	Integrated aluminum feet							Separate aluminum feet
Bearings	D-end	6203-2Z/C3	6204-2Z/C3	6205-2Z/C3	6306-2Z/C3	6306-2Z/C3	6208-2Z/C3	6309-2Z/C3	6310-2Z/C3
	N-end	6203-2Z/C3	6204-2Z/C3	6205-2Z/C3	6206-2Z/C3	6206-2Z/C3	6208-2Z/C3	6209-2Z/C3	6209-2Z/C3
Axially locked bearings	Inner bearing cover	Locked at D-end							
Bearing seal	D-end	V-ring							V-ring
	V-ring	V-ring							V-ring
Lubrication		Permanently lubricated bearings. Grease for bearing temperatures -40...+160°C							
Measuring nipples for condition monitoring of the bearings		Not included							
Rating plates	Material	Aluminum							
Terminal box	Material	Die-cast aluminum alloy, integrated to stator							
	Cover screw materials	Zinc-electroplated steel							
Connections	Openings	2 x (M20 + M20)			2 x (M20 + M25)		2 x (M25 + M25) ¹⁾ 2x(M40+M32+ M12) ²⁾		2x (M40+M16)+2x(M40)
	Terminals	6 terminals for connecton with cable lugs (not included)							
	Cable glands	Optional							
Fan	Material	Glass-fiber enforces polypropylene							
Fan cover	Material	Steel							
	Paint color shade	Munsell blue 8B 4.5/3.25							
	Corrosion class	C3							
Stator winding	Material	Copper							
	Insulation	Insulation class F							
	Winding protection	Optional							3 PTC thermistors, 150 °C
Rotor winding	Material	Die-cast aluminum							
Balancing		Half key balancing							
Key ways		Closed key way							
Drain holes		Drain holes with closable plastic plugs, open on delivery							
External earthing bolt		Optional							
Enclosure		Motor, terminal box and brake electrical components: IP 55							
		Brake mechanical components: IP54							
Cooling method		IC 411							

¹⁾ S, SB, M, MA

²⁾ SC, MC, SMA, SME

Contact us



For more information and contact details:

www.abb.com/motors&generators